



# Udderly Quiet®

## Acoustic Panel

Installation Manual

# TABLE OF CONTENTS

<b>You Should Know</b>	<b>3</b>
<b>Adhesive Mounting Instructions</b>	<b>4</b>
Wall Installation Instructions	4
<b>Ceiling Installation Instructions</b>	<b>7</b>
<b>Hook &amp; Loop Mounting Instructions</b>	<b>9</b>
Wall Installation Instructions	9
<b>Z Clip Mounting Instructions</b>	<b>12</b>
Wall Installation Instructions	12
<b>Z Clip Mounting Instructions (Aluminum Frame Panel)</b>	<b>14</b>
Wall Installation Instructions	14
<b>How to Shorten the Length or Width</b>	<b>16</b>
<b>How to Create a Cut-Out for an Electrical Box or Other Obstruction</b>	<b>18</b>
<b>Cleaning and Maintenance</b>	<b>20</b>
<b>Return Policy</b>	<b>21</b>

# YOU SHOULD KNOW

These instructions serve as a guide. The responsibility for recognizing and compensating for field conditions is with the installer. Thoroughly read all instructions before starting on your project. If you have any questions, contact us Toll Free at **800.558.2058**.

Handle your Udderly Quiet® Acoustic Panels with care. Avoid excessive handling of the panels. The more they are handled, the greater the chance they will be damaged. Do not use a utility knife when opening your acoustic panel boxes.

Avoid contact with sharp objects or edges. The panel finishes are durable, but will not withstand encounters with sharp objects.

If the panels are installed on a wall that is not plumb, misalignment will be apparent. Care should be taken in laying out panel placement and in preparing the wall surface before installation. A majority of installation problems occur due to lack of preparation prior to installation of the mounting hardware.

Ambient light conditions can cause shadowing, magnifying even the slightest misalignment.

When using a variety of mounting methods in an installation, consider the different thicknesses the mounting systems will create between the panel and the wall. It is best to group the panels with the same mounting method so uniformity is achieved.

For wall applications, never install our panels without the Leveling Brackets. The Leveling Brackets are the main load bearing support for the various mounting systems and are absolutely imperative to the longevity and quality of the installation. Use a level reference line when installing the Leveling Brackets to ensure the panels are installed level.

When installing panels with adhesive consider using temporary brackets to hold the panels in place while the adhesive cures. Most adhesives achieve a full cure over a 24 hour period of time, depending on ambient temperature and humidity conditions.

Arrangements can be made to pre-ship the leveling angles for time sensitive large projects.

Always be aware of electric and plumbing lines within the wall/ceiling assemblies. We highly recommend shutting off electricity within the room you are working on.

When resizing or modifying panels you may want to consider wearing a safety mask.

Always wear protective eye gear and gloves when installing our products... safety first!

# ADHESIVE MOUNTING INSTRUCTIONS

## Adhesive Coverage Table

Qty of PL Construction Adhesive (1/4 Bead)	Qty of Power Grab Construction Adhesive (1/4 Bead)	Qty of Acoustic Panels	Size of Acoustic Panels (in.)
1	1	2	24 x 48
1	1	1	48 x 48
1.5	1.5	1	48 x 96

## Wall Installation Instructions

**Tools needed:** Drill or Screw Gun, Level, Caulk Gun, Tape Measure, Pencil, Chalk Line (for large installs), Utility Knife (for cutting or trimming), 80 Grit Sand Paper (for prep of smooth or glossy mounting surfaces)

**Materials needed:** Udderly Quiet® Acoustic Panels come with Leveling Brackets; PL Construction Adhesive or Power Grab Construction Adhesive is recommended.

1. Rough the smooth or glossy mounting surfaces using 80 grit sand paper and clean off debris.
2. Wall surface must be clean, dry, and free of surface obstructions.
3. Using a level, lay out where the panels will be installed across the entire wall surface. Lightly draw reference lines with a pencil as needed. A chalk line is recommended for large installations.

**Please Note:** Take your time with this step. Most sub-quality installs are due to wrong or hurried measurements. This is the most important step in producing a quality installation. Properly laying out the entire acoustic panel installation with reference lines, prior to actual install, will avoid costly mistakes.

4. If the acoustic panels need to be resized or modified, then confirm all measurements before cutting panels. Make all cuts before installing. Please see the "How to Shorten the Length or Width" or "How to Create a Cut-Out for an Electrical Box or Other Obstruction" section on pages 16 and 18.

5. Install the provided leveling brackets to the wall surface using the provided screws. Be certain the leveling brackets are level to one another as these are the primary supports of the panel until the adhesive cures. See diagram below.

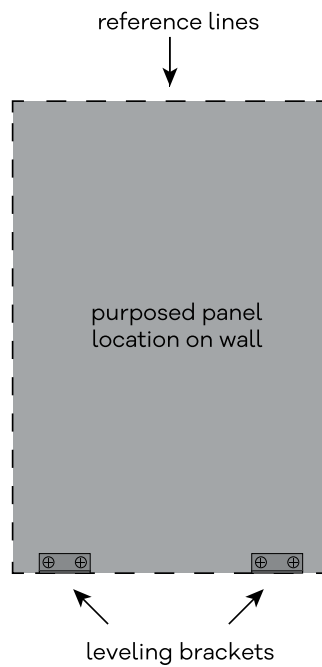

6. Place the panel, fabric side down, on a clean, smooth surface. Apply adhesive around the perimeter (approximately 2 inches from edge) and across the panel diagonally making an "X" pattern. Also, apply 2 to 3 inch circles of adhesive in the field of the panels. See diagram below.

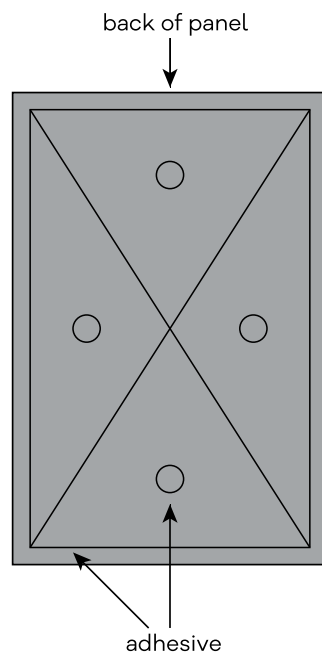

7. Rest the bottom edge of the panel on the leveling brackets and while using the reference lines as a guide, gently press the panel against the wall. **See diagram below.** If shimming is required, take measurements and remove the panel. Shim the panels between the leveling brackets and the bottom edge of the panel to flush align the panel seams. Let the adhesive cure for 24 hours before exposing the panel to traffic.

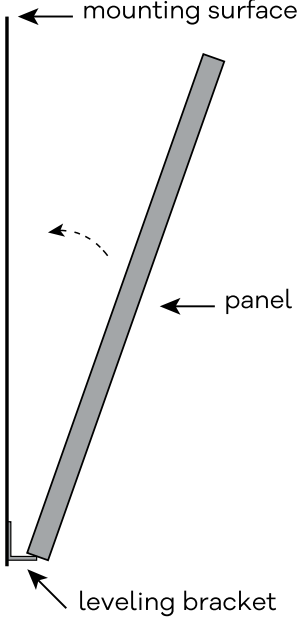

## Ceiling Installation Instructions

**Tools Needed:** Straight Edge, Caulk Gun, Tape Measure, Pencil, Chalk Line (for large installs), Utility Knife (for cutting or trimming), 80 Grit Sand Paper (for prep of smooth or glossy mounting surfaces)

**Materials Needed:** PL Construction Adhesive, 3 inch Finishing Nails

1. Rough the smooth or glossy mounting surfaces using 80 grit sand paper and clean off debris.
2. Ceiling surface must be clean, dry, and free of any surface obstructions.
3. Using a straight edge lay out where the panels will be installed across the entire ceiling surface. Lightly draw reference lines with a pencil as needed. A chalk line is recommended for large installations.

**Please Note:** Take your time with this step. Most sub-quality installs are due to wrong or hurried measurements. This is the most important step in producing a quality installation. Properly laying out the entire acoustic panel installation with reference lines, prior to actual install, will avoid costly mistakes.

4. If the acoustic panels need to be resized or modified, then confirm all measurements before cutting panels. Make all cuts before installing. Please see the "How to Shorten the Length or Width" or "How to Create a Cut-Out for an Electrical Box or Other Obstruction" section on pages 16 and 18.

5. Place the panel, fabric side down, on a clean, smooth surface. Apply adhesive around the perimeter (approximately 2 inches from edge) and across the panel diagonally making an "X" pattern. Also, apply 2 to 3 inch circles of adhesive in the field of the panels. See diagram below.

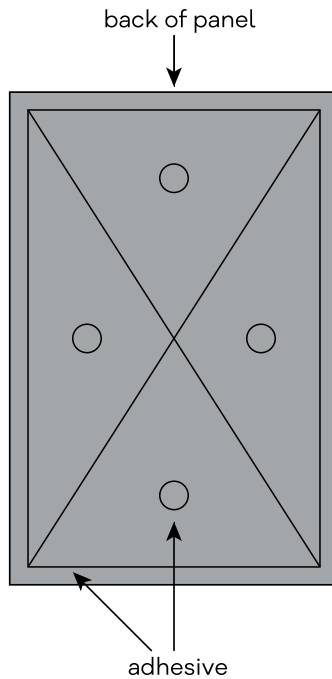

6. Using the reference lines as a guide, gently press the panel against the ceiling. While another worker holds the panel in place, install 3 inch finishing nails 18 to 24 inches apart around the entire perimeter of the panel. Install the nails on a 45° angle and be sure to leave enough of the nail exposed for easy removal after the adhesive cures. Check for "panel sag" in the center of the panel. If the panel is sagging install more nails as needed.

**Please Note:** Try to limit the amount of nails so panels do not appear damaged after the nails are removed. It is advisable to puncture a panel in an inconspicuous spot to see if the nail hole will blemish the fabric.

7. Let the adhesive cure for 24 hours before removing the nails. After removing the nails "brush" the fabric with clean hands to hide the nail hole.



# HOOK & LOOP MOUNTING INSTRUCTIONS

## Wall Installation Instructions

**Tools Needed:** Drill or Screw Gun, Level, Tape Measure, Pencil, Chalk Line (for large installs), Utility Knife (for cutting or trimming), Small Hand Roller or Putty Knife

**Materials Needed:** Udderly Quiet® Acoustic Panels come with Leveling Brackets and Hook & Loop Components.

1. Wall surface should be clean, dry and free of any surface obstructions.
2. Using a level, layout where the panels will be installed across the entire wall surface. Lightly draw reference lines with pencil as needed. The hook & loop mounting system creates a 1/8 inch gap between the wall and panel.

**Please Note:** Take your time with this step. Most sub-quality installs are due to wrong or hurried measurements. This is the most important step in producing a quality installation. Properly laying out the entire acoustic panel installation with reference lines, prior to actual install, will avoid costly mistakes.

3. If the acoustic panels need to be resized or modified, then confirm all measurements before cutting panels. Make all cuts before installing. Please see the "How to Shorten the Length or Width" or "How to Create a Cut-Out for an Electrical Box or Other Obstruction" sections on pages 16 and 18.

4. Install the provided leveling brackets to the wall surface using the provided screws. Be certain the leveling brackets are level to one another, as these are the primary supports. See diagram below.

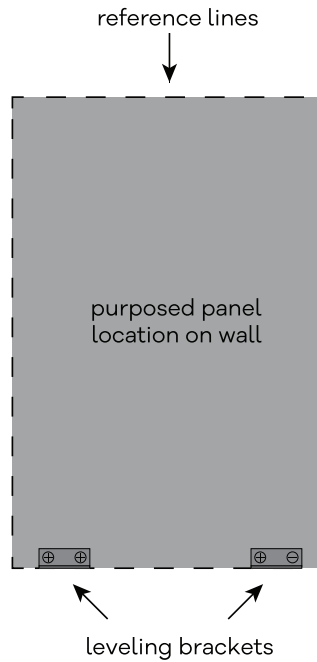

5. Measure where the factory installed loop is located on the back of the panel. Transfer the measurement to the wall surface using the reference lines from Step 2. Carefully remove the release paper from the hook portion of the system and press it firmly against the wall. Use a small roller or putty knife to remove any entrapped air bubbles behind the hook portion.

6. Rest the bottom edge of the panel on the leveling angles and while using the reference lines as a guide, press the panel against the wall. See diagram below.

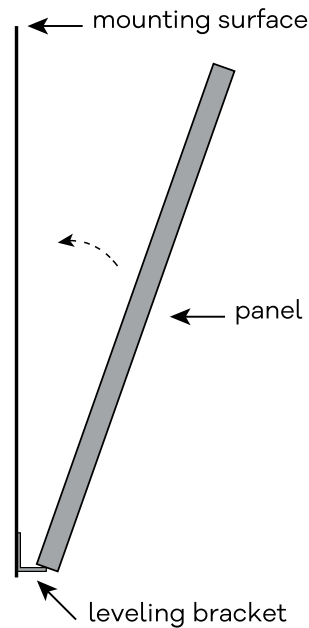

7. If panel is not level, take measurements and remove the panel. Shim the panels between the leveling brackets and the bottom edge of the panel to flush align the panel seams.

**Please Note:** When panel removal is necessary, carefully use a putty knife to assist in breaking the hook & loop bond. Pulling the panel from the wall, without first using a putty knife to break the hook & loop bond, will cause damage to the panel or wall. Allow 24 hours for hook & loop adhesive to cure before attempting to remove panel from wall, otherwise, the adhesive may pull away from the wall.

# Z CLIP MOUNTING INSTRUCTIONS

## Wall Installation Instructions

**Tools Needed:** Drill or Screw Gun, Level, Tape Measure, Pencil, Chalk Line (for large installs), Utility Knife (for cutting or trimming)

**Materials Needed:** Udderly Quiet® Acoustic Panels come with Leveling Brackets and Z Clip Hardware.

1. Wall surface should be clean, dry, and free of any surface obstructions.
2. Measure and note the location of the factory installed Z clips on the back of the panel. A one inch clearance is required between the top of the panel and any intersecting planes like ceilings or bulkheads. The clearance is needed for the panels to slip into place. The Z clip mounting system will create a 3/16 inch gap between the panel and wall surface.
3. Using a level, layout where the panels will be installed across the entire wall surface. Keep in mind that a one inch clearance at ceilings and bulkheads is required. Lightly draw reference lines with a pencil as needed.

**Please Note:** Take your time with this step. Most sub-quality installs are due to wrong or hurried measurements. This is the most important step in producing a quality installation. Properly laying out the entire acoustic panel installation with reference lines, prior to actual install, will avoid costly mistakes.

4. If the acoustic panels need to be resized or modified, then confirm all measurements before cutting panels. Make all cuts before installing. Please see the "How to Shorten the Length or Width" or "How to Create a Cut-Out for an Electrical Box or Other Obstruction" sections on pages 16 and 18.

5. Transfer the Z clip location dimensions (measured in Step 2) to the wall. Mark the locations for the mounting bar and install with the provided screws. Pre-drilling of the mounting bar is recommended. Install the provided leveling brackets to the wall surface using the provided screws. Be certain the leveling brackets are level to one another as these are the primary supports. See diagram below.

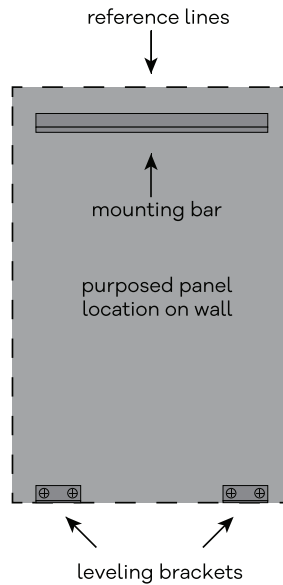

6. Lift the panel to a position that will allow the factory installed Z clips to slide down onto the mounting bar. Using the reference line as a guide, carefully slide the panel into position allowing the bottom to rest on the leveling brackets. See diagram below.

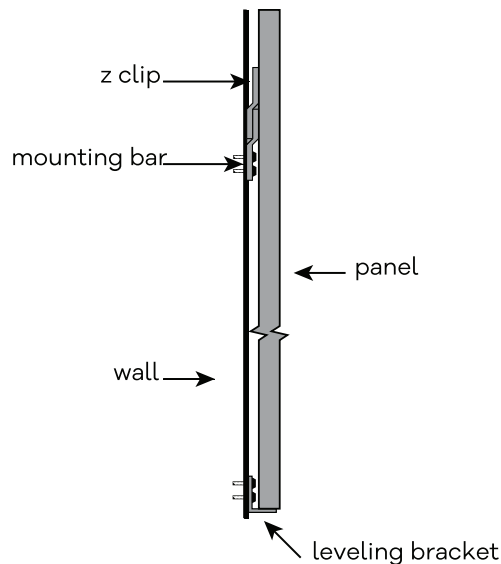

7. If panel is not level, take measurements and remove the panel. Shim the panels between the leveling brackets and the bottom edge of the panel to flush align the panel seams.

# Z CLIP MOUNTING INSTRUCTIONS (PANEL WITH ALUMINUM FRAME)

## Wall Installation Instructions

**Tools Needed:** Drill or Screw Gun, Level, Tape Measure, Pencil, Chalk Line (for large installs), Utility Knife (for cutting or trimming)

**Materials Needed:** Udderly Quiet® Acoustic Panels come with Leveling Brackets and Z Clip Hardware.

1. Wall surface should be clean, dry, and free of any surface obstructions.
2. Measure and note the location of the factory installed Z clips on the back of the panel. A one inch clearance is required between the top of the panel and any intersecting planes like ceilings or bulkheads. The clearance is needed for the panels to slip into place. The Z clip mounting system will create a 3/16 inch gap between the panel and wall surface.
3. Using a level, layout where the panels will be installed across the entire wall surface. Keep in mind that a one inch clearance at ceilings and bulkheads is required. Lightly draw reference lines with a pencil as needed.

**Please Note:** Take your time with this step. Most sub-quality installs are due to wrong or hurried measurements. This is the most important step in producing a quality installation. Properly laying out the entire acoustic panel installation with reference lines, prior to actual install, will avoid costly mistakes.

4. If the acoustic panels need to be resized or modified, then confirm all measurements before cutting panels. Make all cuts before installing. Please see the "How to Create a Cut-Out for and Electrical Box or Other Obstruction" section on page 18.

**Please Note:** We do not recommend shortening the length or width of Udderly Quiet® Acoustic Panels with Aluminum Edges. When ordering these panels, make sure all measurements compensate for the variances and obstacles on site.

5. Transfer the Z clip location dimensions (measured in Step 2) to the wall. Mark the locations for the receiving Z clips and install with the provided screws. Install the provided leveling brackets to the wall surface using the provided screws. Be certain the leveling brackets are level to one another as these are the primary supports. See diagram below.

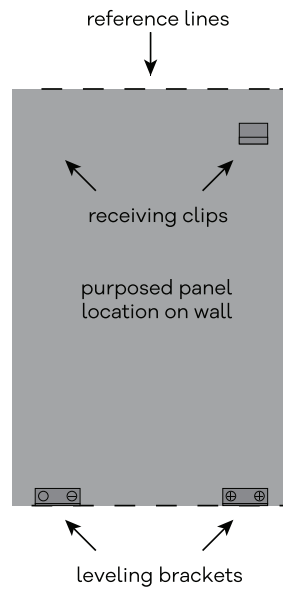

6. Lift the panel to a position that will allow the factory installed Z clips to slide down into the wall mounted Z clips. Using the reference line as a guide, carefully slide the panel into position, allowing the bottom to rest on the leveling brackets. See diagram below.

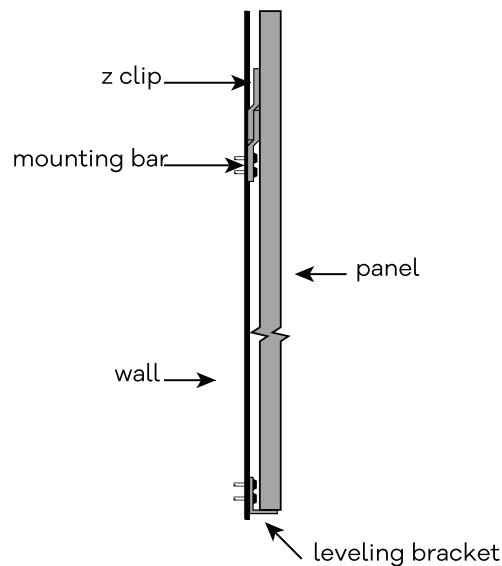

7. If panel is not level, take measurements and remove the panel. Shim the panels between the leveling brackets and the bottom edge of the panel to flush align the seams.

# HOW TO SHORTEN THE LENGTH OR WIDTH

## You Should Know:

Always double check the measurements before trimming or cutting your acoustic panels. The tried and true “measure twice, cut once” rule applies.

We do not recommend shortening the length or width of Udderly Quiet® Acoustic Panels with Aluminum Edges. When ordering these panels, make sure all measurements compensate for the variances and obstacles on site.

**Tools Needed:** Straight Edge, Masking Tape, Serrated Knife, Scissors, Tape Measure

**Materials Needed:** Clearco 444 Spray Adhesive

1. At the desired dimensions, mark the fabric covering with masking tape. Confirm your measurements. Lay the panel face down on a clean, smooth, stable surface.
2. In the area that will be trimmed, carefully remove the retention staples and slowly peel the fabric covering back from the panel core. Turn the panel face up and continue to peel the fabric covering away from the panel, using the chalk line as a reference. Do not peel the fabric covering farther than needed. See diagram below.

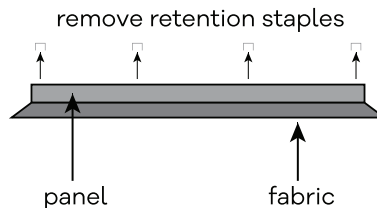



**3.** When the fabric covering is peeled back to the proper point, use a straight edge and a serrated knife to trim the panel core. Be very careful not to cut the fabric. Make a series of cuts through the panel core, as opposed to cutting with one pass, until the desired amount of panel is removed. See diagram below.

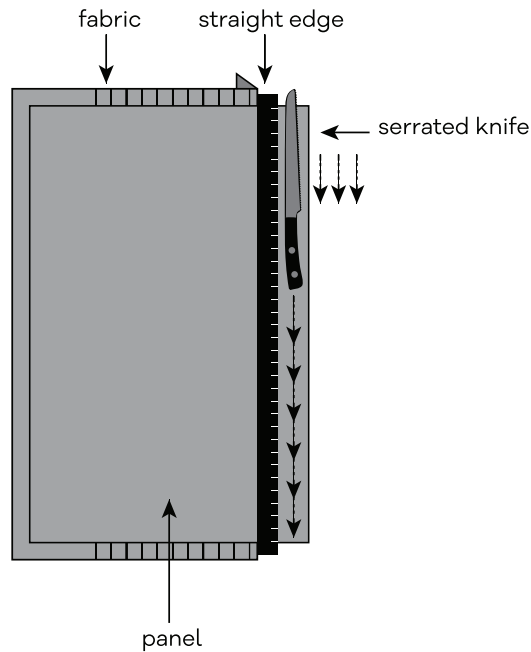

**4.** Clean off excess panel material from the peeled back fabric covering. Apply the spray adhesive to the newly cut edge of the panel and the back of the fabric. Protect the fabric covering from overspray and do not over-apply adhesive. Both of these miscalculations could result in a blemished covering. Rewrap the fabric covering around the panel edges.

**5.** Finish by trimming the excess fabric covering with a sharp pair of scissors. Check to see if the panel fits. Install the panel per installation instructions.

# HOW TO CREATE A CUT-OUT FOR AN ELECTRICAL BOX OR OTHER OBSTRUCTION

## You Should Know:

Always double check the measurements before trimming or cutting your acoustic panels. The tried and true “measure twice, cut once” rule applies.

We highly recommend shutting off the electricity within the room you are working in before starting these instructions.

**Tools Needed:** Straight Edge, Chalk (cleanable), Utility Knife, Screw Driver (for electrical box plate removal)

**Materials Needed:** Clearco 444 Spray Adhesive, Electrical Box Extender Sleeve

1. Remove the electrical box cover. Trace the rim of the box with a piece of cleanable chalk. Place the panel, back side to wall, in the desired location. Gently apply pressure to the panel in the area where the electrical box is located. This will transfer the chalked electrical box outline onto the back of the panel.

2. Place the panel face down on a clean, smooth, stable surface. Carefully using a straight edge and utility knife score the transferred chalk line. Making an “X”, cut diagonally from corner to corner of the scored line. Layer at a time continue to cut and remove the core material of the panel.

3. Once the remainder of the core material is removed and the fabric is exposed, using a utility knife make an “X” by cutting the fabric diagonally, corner to corner. To avoid pulling and stretching the fabric, make several small passes with the utility knife, until the fabric is completely cut through. See diagram below.

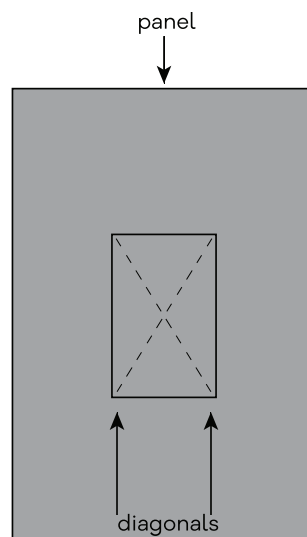

4. Apply the spray adhesive to the edges of the cut-out and to the back of the fabric. Protect fabric covering from overspray and do not over-apply adhesive. Both of the miscalculations could result in a blemished covering. Wrap the fabric covering around the edge of cut-out. **See diagram below.**

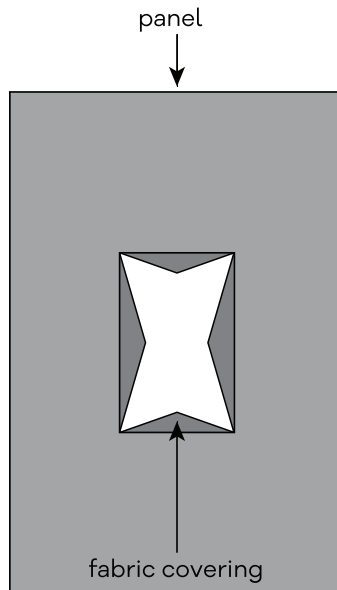

5. Let the adhesive set for a few moments. Install the panel in the desired location per installation instructions.

6. Check for fit and install an extender sleeve to the electrical box. Extender sleeves come in a variety of sizes and are available in most electrical departments of home improvement centers. To choose the proper size extender sleeve for your application; add the thickness of the panel to the wall gap created by the mounting method you are using. This will give you the depth the extender sleeve must reach to the electrical box.

7. To complete the installation, reinstall the electrical box cover.

# CLEANING AND MAINTENANCE

All panel finishes are subject to soiling and wear. A regular maintenance program, initiated at the earliest time after installation, will prevent staining from soil and dirt build up. Preventative maintenance adjacent to HVAC vents is especially advisable.

Clean all of our fabric coverings with water based cleaning agents or a mild, water free solvent. Blot the soiled areas with a damp cloth containing the water and soap solution. Do not over wet the panel. Test any cleaning agents on an inconspicuous area of the panel before applying the solution to the rest of the surface.

Grease and oil should be cleaned immediately upon contact. Remove excess by blotting. Remove the remaining residue with a clean damp cloth containing warm water and a mild soap solution.

For cleaning custom fabrics, manufacturer instructions should be followed as long as the instructions do not conflict with the information on this page.

Care should be taken when using harsh cleaning agents or chemicals around or near the panels. The fumes from these products may affect the bonding adhesives within the panel. Make sure there is adequate ventilation to minimize the chance of damage.

Avoid excess heat and moisture; finishes or bonding adhesives may be compromised if exposed. The temperature should be maintained between 50°F to 85°F and humidity levels should range from 20% to 50% for maximum life of panels.

The panels should never be submerged in water, nor soaked to the core material.

# ACOUSTIC PANELS RETURN POLICY

**Should you find it necessary to return or replace your recent purchase of our product, please adhere to the following guidelines:**

1. ALL CUSTOM and INSTOCK panels must be inspected within 48 hours of receiving, in order to make a claim for any visible damage due to shipping, packaging, or receiving.
2. ALL panels are replaceable if they are received damaged and signed damaged at receiving. American Micro Industries, Inc. will be responsible for replacing the damaged panels, as well as return shipping.
3. ALL panels cannot be returned or replaced due to customer dissatisfaction with choice of fabric, color, or custom dimensions that are within American Micro Industries, Inc. 1/8 tolerance. No replacements are accepted on custom or special order items after 15 days.
4. ALL replacements must be authorized by American Micro Industries, Inc. Unauthorized returns will not be accepted, refunded, or replaced and may be refused at receiving.
5. ALL inquiries must be made within fifteen (15) days after the date of the original shipment, for orders within the United States. For foreign orders, the inquiry must be made within thirty (30) days of the initial shipment.
6. To obtain authorization, please call our customer service department toll free at **1-800-558-2058** or e-mail us at **[returns@americanmicroinc.com](mailto:returns@americanmicroinc.com)**.

# RETURN PROCEDURE & POLICIES

## Return Authorization

All inquiries for replacements must be authorized within fifteen (15) days after the receiving date. All replacements must be authorized by Soundproofcow.com before a customer can send the order back and/or request a replacement. Unauthorized returns will not be accepted or refunded, and may be refused when received. To obtain authorization you must request authorization within fifteen (15) days of the receiving date.

## Return Condition

All returned merchandise must be unused and returned in the condition it was originally received, with all original packaging. Returns must be 100% complete, including all components, hardware and/or any accompanying items. Any return that does not include the preceding items will not be refunded and may be refused when received. If any component of the returned product(s) is missing, Return Procedure will be breached and we may in our sole and absolute discretion reject the entire return or choose to impose additional charges against the Customer for replacement of the missing component(s). Any return containing products that appear used, damaged in any way, or with missing components will not be refunded. No returns can be made on custom or special order items. No returns can be made on clearance items, including surplus and damage-discontinued items.

## Refund

All authorized replacements will be replaced at no cost, based on the condition of the panels and the reason for the replacement. No refunds will be granted on custom or special order panels.

## Return Shipment

If customer has requested a replacement of panels outside of the 15 day window, they will be responsible for shipment of the replacement panels. Replacements can be approved at no cost after the 15 days; however the customer is responsible for shipping their product. ALL replacements will be scheduled for production on a 7-10 business day time frame.